



# PHOTOCOUPLER PS2706-1

## AC INPUT RESPONSE DARLINGTON TRANSISTOR SOP MULTI PHOTOCOUPLER SERIES

–NEPOC Series–

### DESCRIPTION

The PS2706-1 is an optically coupled isolator containing a GaAs light emitting diode and an NPN silicon darlington-connected phototransistor.

This is mounted in a plastic SOP (Small Out-line Package) for high density applications.

This package has shield effect to cut off ambient light.

### FEATURES

- AC input response
- High current transfer ratio (CTR = 2 000 % TYP.)
- High isolation voltage (BV = 3 750 Vr.m.s.)
- Small and thin (SOP) package
- High-speed switching ( $t_r, t_f = 200 \mu s$  TYP.)
- Ordering number of taping product: PS2706-1F3, F4
- UL approved: File No. E72422 (S)
- VDE0884 approved (Option)

### APPLICATIONS

- Hybrid IC
- Telephone, Exchange equipment
- FA/OA equipment
- Programmable logic controllers

### ORDERING INFORMATION (Solder Contains Lead)

Part Number	Package	Safety Standard Approval
PS2706-1	4-pin SOP	Standard specification products • UL approved
PS2706-1-V	4-pin SOP	VDE0884 specification products (Option)

### ORDERING INFORMATION (Pb-Free)

Part Number	Package	Safety Standard Approval
PS2706-1-A	4-pin SOP	Standard specification products • UL approved
PS2706-1-V-A	4-pin SOP	VDE0884 specification products (Option)

The information in this document is subject to change without notice. Before using this document, please confirm that this is the latest version.

★ **PACKAGE DIMENSIONS (in millimeters)**

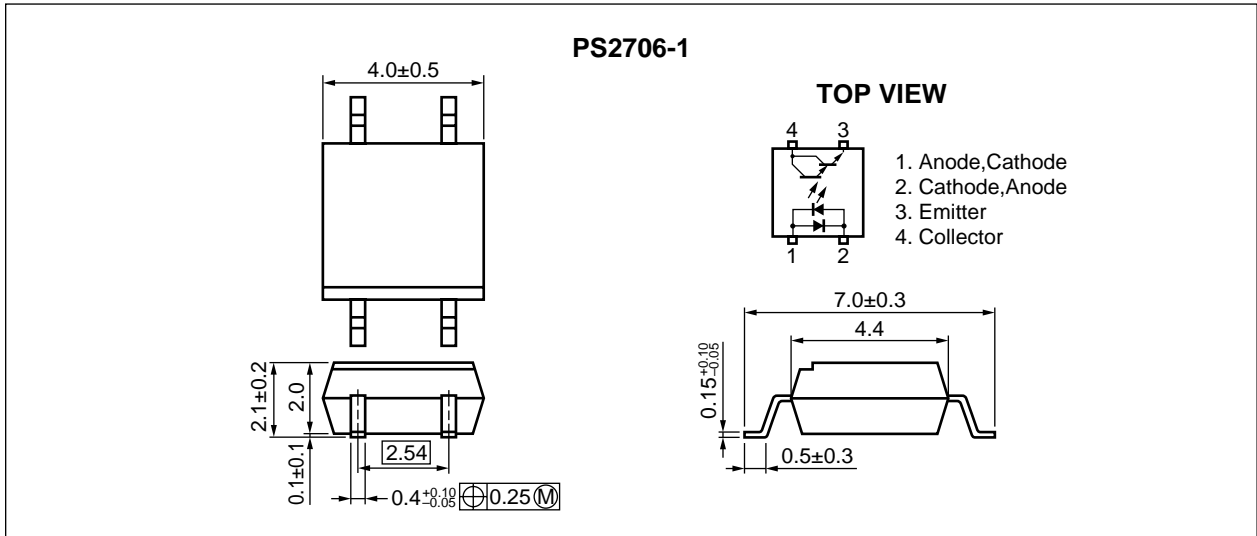

**ABSOLUTE MAXIMUM RATINGS (T<sub>A</sub> = 25 °C, unless otherwise specified)**

Parameter		Symbol	Ratings	Unit
Diode	Forward Current (DC)	I <sub>F</sub>	±50	mA
	Power Dissipation Derating	ΔP <sub>D</sub> /°C	0.8	mW/°C
	Power Dissipation	P <sub>D</sub>	80	mW
	Peak Forward Current <sup>*1</sup>	I <sub>FP</sub>	±1	A
Transistor	Collector to Emitter Voltage	V <sub>CEO</sub>	40	V
	Emitter to Collector Voltage	V <sub>ECO</sub>	6	V
	Collector Current	I <sub>C</sub>	200	mA
	Power Dissipation Derating	ΔP <sub>C</sub> /°C	1.5	mW/°C
	Power Dissipation	P <sub>C</sub>	150	mW
Isolation Voltage <sup>*2</sup>		BV	3 750	Vr.m.s.
Operating Ambient Temperature		T <sub>A</sub>	-55 to +100	°C
Storage Temperature		T <sub>stg</sub>	-55 to +150	°C

\*1 PW = 100 μs, Duty Cycle = 1 %

\*2 AC voltage for 1 minute at T<sub>A</sub> = 25 °C, RH = 60 % between input and output

**ELECTRICAL CHARACTERISTICS (T<sub>A</sub> = 25 °C)**

Parameter		Symbol	Conditions	MIN.	TYP.	MAX.	Unit
Diode	Forward Voltage	V <sub>F</sub>	I <sub>F</sub> = ±5 mA		1.1	1.4	V
	Terminal Capacitance	C <sub>t</sub>	V = 0 V, f = 1 MHz		60		pF
Transistor	Collector to Emitter Dark Current	I <sub>CEO</sub>	I <sub>F</sub> = 0 mA, V <sub>CE</sub> = 40 V			400	nA
Coupled	Current Transfer Ratio (I <sub>c</sub> /I <sub>F</sub> )	CTR	I <sub>F</sub> = ±1 mA, V <sub>CE</sub> = 2 V	200	2 000		%
	CTR Ratio <sup>*1</sup>	CTR1/ CTR2	I <sub>F</sub> = ±1 mA, V <sub>CE</sub> = 2 V	0.3	1.0	3.0	
	Collector Saturation Voltage	V <sub>CE (sat)</sub>	I <sub>F</sub> = ±1 mA, I <sub>c</sub> = 2 mA			1.0	V
	Isolation Resistance	R <sub>I-o</sub>	V <sub>I-o</sub> = 1 kV <sub>DC</sub>	10 <sup>11</sup>			Ω
	Isolation Capacitance	C <sub>I-o</sub>	V = 0 V, f = 1 MHz		0.4		pF
	Rise Time <sup>*2</sup>	t <sub>r</sub>	V <sub>CC</sub> = 5 V, I <sub>c</sub> = 2 mA, R <sub>L</sub> = 100 Ω		200		μs
	Fall Time <sup>*2</sup>	t <sub>f</sub>			200		

\*1 CTR1 = I<sub>c1</sub>/I<sub>F1</sub>, CTR2 = I<sub>c2</sub>/I<sub>F2</sub>

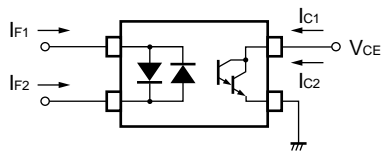

\*2 Test circuit for switching time

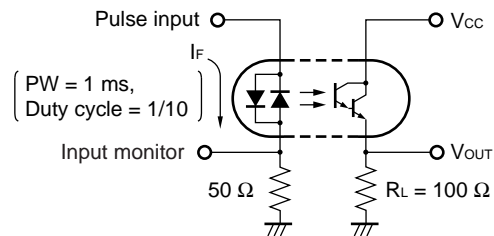

★ TYPICAL CHARACTERISTICS ( $T_A = 25\text{ }^\circ\text{C}$ , unless otherwise specified)

DIODE POWER DISSIPATION vs. AMBIENT TEMPERATURE

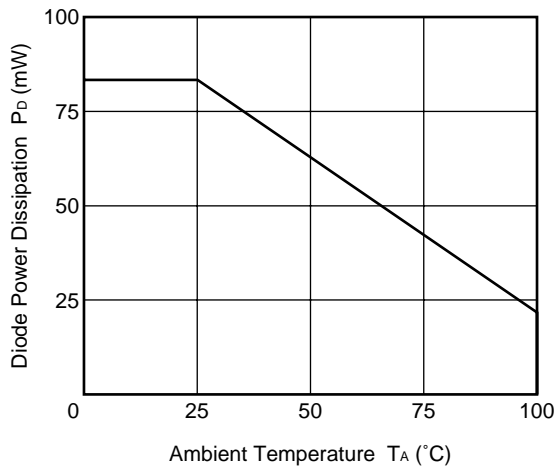

TRANSISTOR POWER DISSIPATION vs. AMBIENT TEMPERATURE

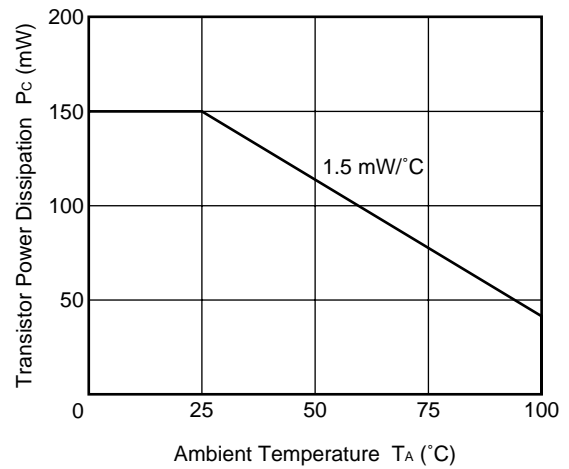

FORWARD CURRENT vs. FORWARD VOLTAGE

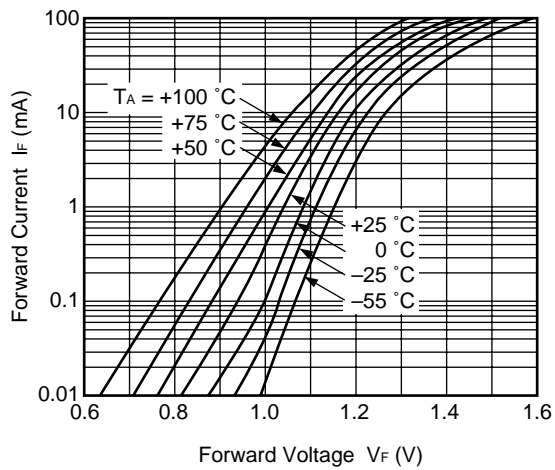

FORWARD CURRENT vs. FORWARD VOLTAGE

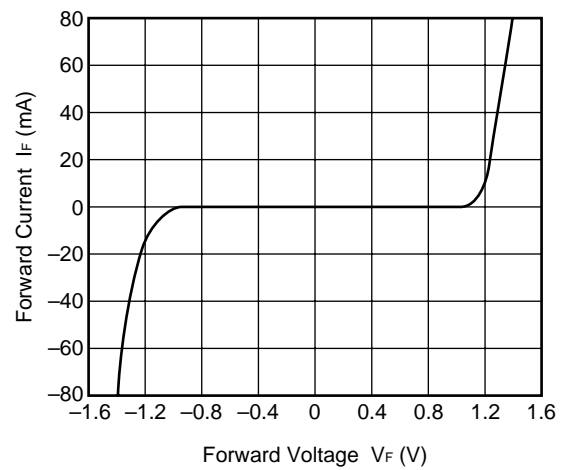

COLLECTOR TO EMITTER DARK CURRENT vs. AMBIENT TEMPERATURE

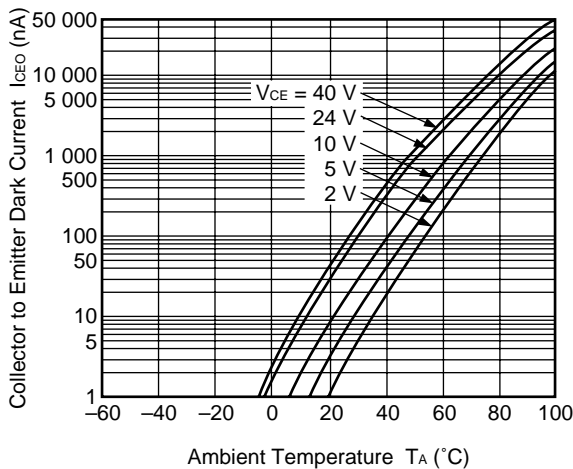

COLLECTOR CURRENT vs. COLLECTOR SATURATION VOLTAGE

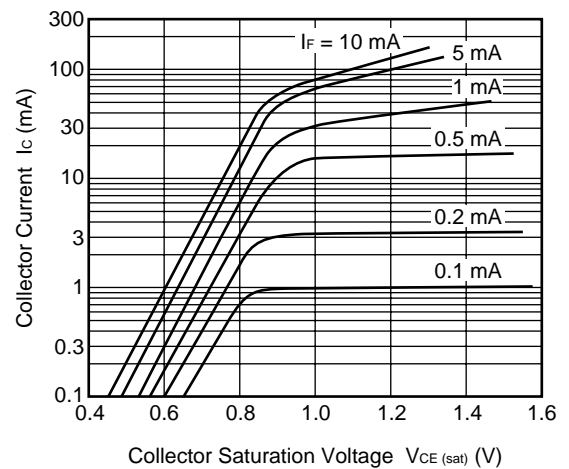

COLLECTOR CURRENT vs. COLLECTOR TO EMITTER VOLTAGE

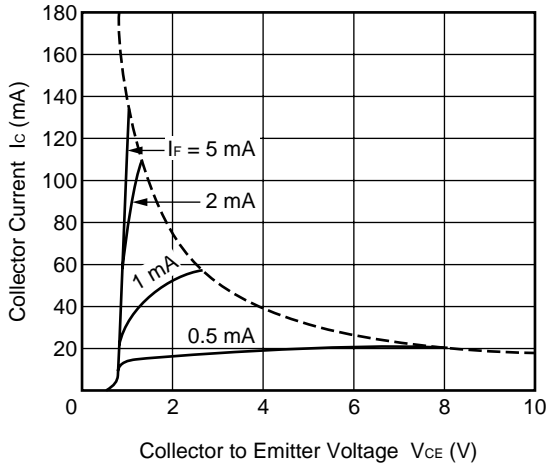

NORMALIZED CURRENT TRANSFER RATIO vs. AMBIENT TEMPERATURE

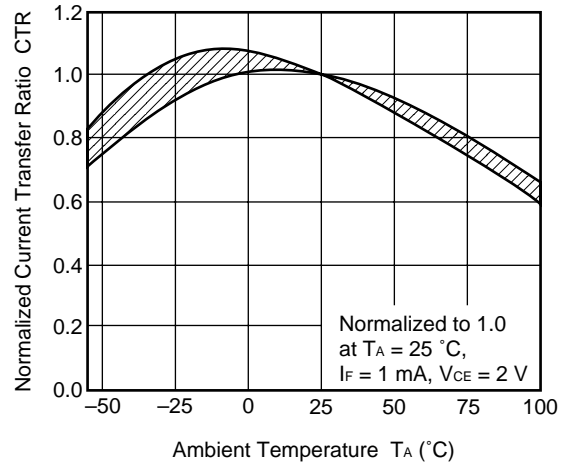

CURRENT TRANSFER RATIO vs. FORWARD CURRENT

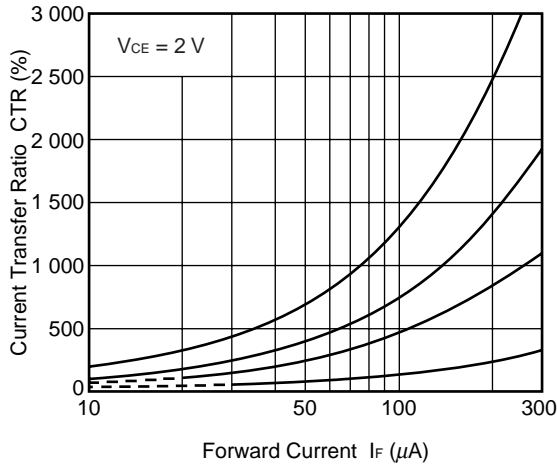

SWITCHING TIME vs. LOAD RESISTANCE

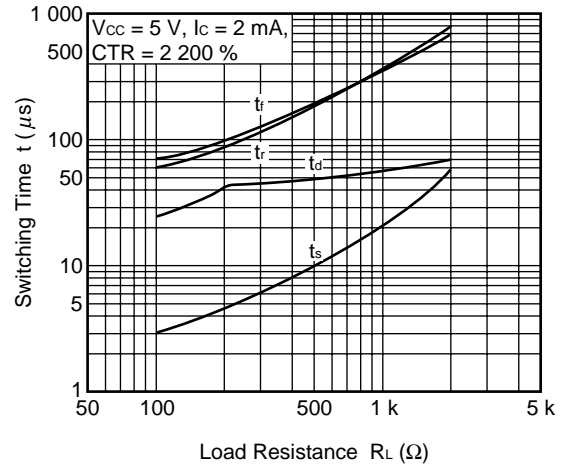

CURRENT TRANSFER RATIO vs. FORWARD CURRENT

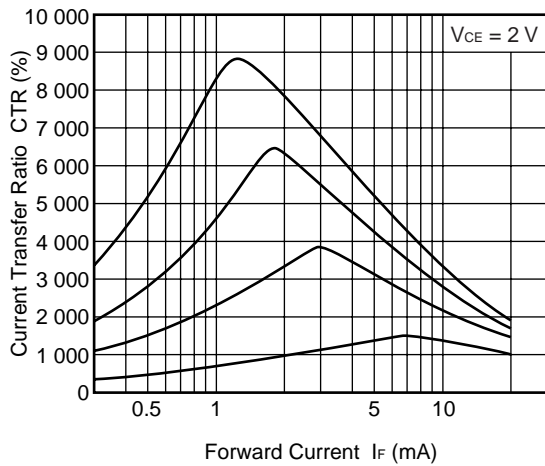

SWITCHING TIME vs. LOAD RESISTANCE

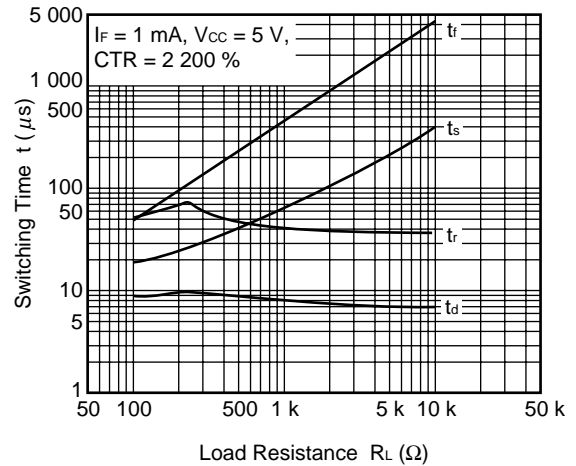

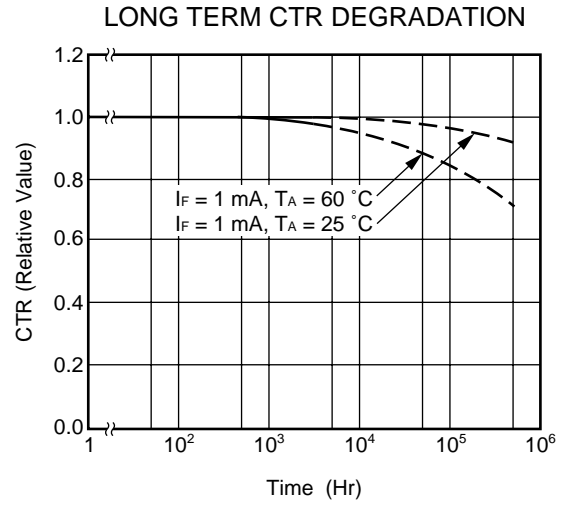
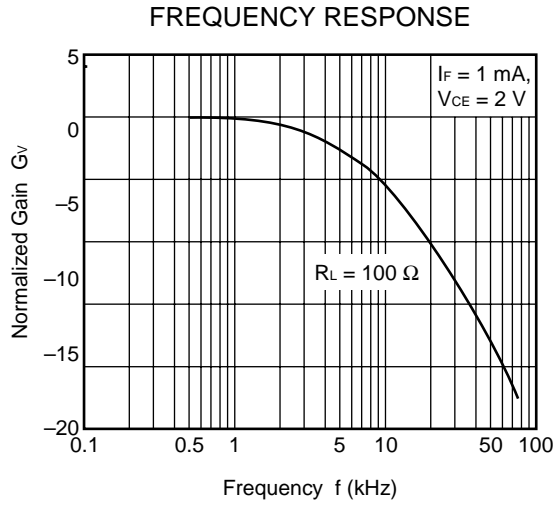

**Remark** The graphs indicate nominal characteristics.

★ TAPING SPECIFICATIONS (in millimeters)

Outline and Dimensions (Tape)

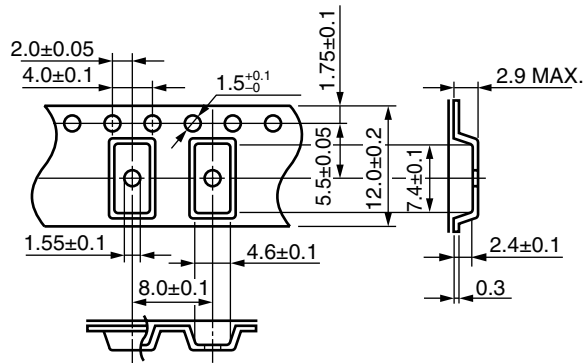

Tape Direction

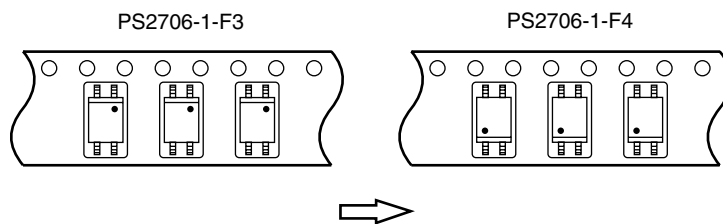

Outline and Dimensions (Reel)

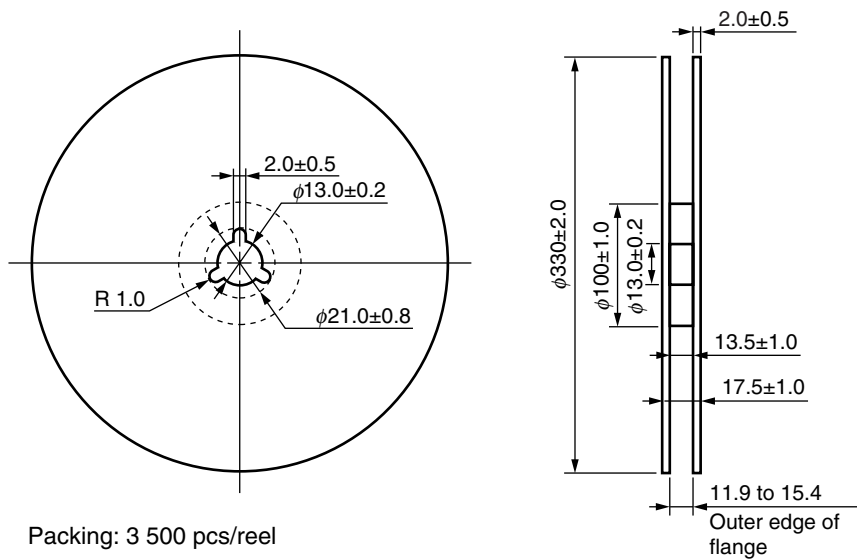

Packing: 3 500 pcs/reel



★ NOTES ON HANDLING

1. Recommended soldering conditions

(1) Infrared reflow soldering

- Peak reflow temperature 260°C or below (package surface temperature)
- Time of peak reflow temperature 10 seconds or less
- Time of temperature higher than 220°C 60 seconds or less
- Time to preheat temperature from 120 to 180°C 120±30 s
- Number of reflows Three
- Flux Rosin flux containing small amount of chlorine (The flux with a maximum chlorine content of 0.2 Wt% is recommended.)

Recommended Temperature Profile of Infrared Reflow

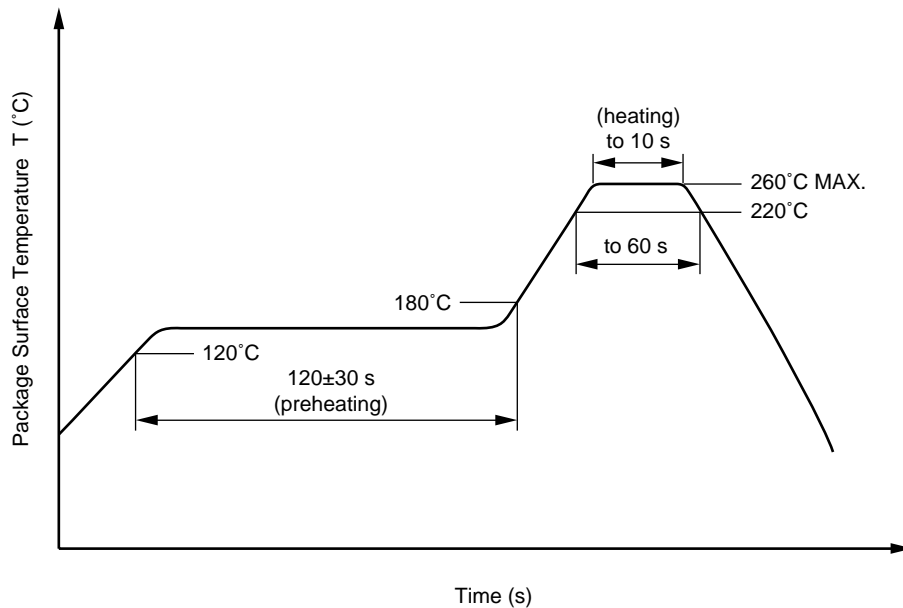

(2) Wave soldering

- Temperature 260°C or below (molten solder temperature)
- Time 10 seconds or less
- Preheating conditions 120°C or below (package surface temperature)
- Number of times One (Allowed to be dipped in solder including plastic mold portion.)
- Flux Rosin flux containing small amount of chlorine (The flux with a maximum chlorine content of 0.2 Wt% is recommended.)

(3) Cautions

- Fluxes  
Avoid removing the residual flux with freon-based and chlorine-based cleaning solvent.

2. Cautions regarding noise

Be aware that when voltage is applied suddenly between the photocoupler's input and output or between collector-emitters at startup, the output side may enter the on state, even if the voltage is within the absolute maximum ratings.

★ **USAGE CAUTIONS**

1. Protect against static electricity when handling.
2. Avoid storage at a high temperature and high humidity.

**SPECIFICATION OF VDE MARKS LICENSE DOCUMENT (VDE0884)**

Parameter	Symbol	Speck	Unit
Application classification (DIN VDE 0109) for rated line voltages $\leq 300$ Vr.m.s. for rated line voltages $\leq 600$ Vr.m.s.		IV III	
Climatic test class (DIN IEC 68 Teil 1/09.80)		55/100/21	
Dielectric strength maximum operating isolation voltage Test voltage (partial discharge test, procedure a for type test and random test) $U_{pr} = 1.2 \times U_{IORM}, P_d < 5$ pC	$U_{IORM}$ $U_{pr}$	710 850	$V_{peak}$ $V_{peak}$
★ Test voltage (partial discharge test, procedure b for all devices test) $U_{pr} = 1.6 \times U_{IORM}, P_d < 5$ pC	$U_{pr}$	1 140	$V_{peak}$
Highest permissible overvoltage	$U_{TR}$	6 000	$V_{peak}$
Degree of pollution (DIN VDE 0109)		2	
Clearance distance		> 5	mm
Creepage distance		> 5	mm
Comparative tracking index (DIN IEC 112/VDE 0303 part 1)	CTI	175	
Material group (DIN VDE 0109)		III a	
Storage temperature range	$T_{stg}$	-55 to +150	°C
Operating temperature range	$T_A$	-55 to +100	°C
Isolation resistance, minimum value $V_{IO} = 500$ V dc at $T_A = 25$ °C $V_{IO} = 500$ V dc at $T_A$ MAX. at least 100 °C	Ris MIN. Ris MIN.	$10^{12}$ $10^{11}$	$\Omega$ $\Omega$
Safety maximum ratings (maximum permissible in case of fault, see thermal derating curve) Package temperature Current (input current $I_F, P_{si} = 0$ ) Power (output or total power dissipation) Isolation resistance $V_{IO} = 500$ V dc at $T_A = 175$ °C ( $T_{si}$ )	$T_{si}$ $I_{si}$ $P_{si}$ Ris MIN.	150 200 300 $10^9$	°C mA mW $\Omega$

Subject: Compliance with EU Directives

CEL certifies, to its knowledge, that semiconductor and laser products detailed below are compliant with the requirements of European Union (EU) Directive 2002/95/EC Restriction on Use of Hazardous Substances in electrical and electronic equipment (RoHS) and the requirements of EU Directive 2003/11/EC Restriction on Penta and Octa BDE.

CEL Pb-free products have the same base part number with a suffix added. The suffix –A indicates that the device is Pb-free. The –AZ suffix is used to designate devices containing Pb which are exempted from the requirement of RoHS directive (\*). In all cases the devices have Pb-free terminals. All devices with these suffixes meet the requirements of the RoHS directive.

This status is based on CEL’s understanding of the EU Directives and knowledge of the materials that go into its products as of the date of disclosure of this information.

Restricted Substance per RoHS	Concentration Limit per RoHS (values are not yet fixed)	Concentration contained in CEL devices	
		-A	-AZ
Lead (Pb)	< 1000 PPM	Not Detected	(*)
Mercury	< 1000 PPM	Not Detected	
Cadmium	< 100 PPM	Not Detected	
Hexavalent Chromium	< 1000 PPM	Not Detected	
PBB	< 1000 PPM	Not Detected	
PBDE	< 1000 PPM	Not Detected	

If you should have any additional questions regarding our devices and compliance to environmental standards, please do not hesitate to contact your local representative.

**Important Information and Disclaimer:** Information provided by CEL on its website or in other communications concerning the substance content of its products represents knowledge and belief as of the date that it is provided. CEL bases its knowledge and belief on information provided by third parties and makes no representation or warranty as to the accuracy of such information. Efforts are underway to better integrate information from third parties. CEL has taken and continues to take reasonable steps to provide representative and accurate information but may not have conducted destructive testing or chemical analysis on incoming materials and chemicals. CEL and CEL suppliers consider certain information to be proprietary, and thus CAS numbers and other limited information may not be available for release.

In no event shall CEL’s liability arising out of such information exceed the total purchase price of the CEL part(s) at issue sold by CEL to customer on an annual basis.

See CEL Terms and Conditions for additional clarification of warranties and liability.